



EHPR Valve Calibration 3PYP Planter Reverse Steering

Used with:

- 3PYP s/n A1025+
- Field-upgraded lower 3PYP s/n



When you see this symbol, the subsequent instructions and warnings are serious - follow without exception. Your life and the lives of others depend on it!

General Information

These instructions explain how to calibrate the Electro-Hydraulic Proportional Reducing (EHPR) valve which controls reverse steering on new, upgraded or repaired 3PYP planters.

Kit	Description
401-615A	HAND HELD CALIBRATION TOOL KIT

Background: EHPR valves control the direction of rotation and rate of movement of the caster wheels. The valves require an *Imin* (input minimum) value to be stored into the ECU (electronic control unit) during the first setup of the steering system. The *Imin* value determines the minimum threshold of movement of the caster wheels left and right. The *Imin* values need to be calibrated properly for the system to respond correctly with the tractor wheel rotation. Failure to calibrate or calibrating incorrectly may make the system have unintended movements or have a sluggish response to the tractor wheel movement.

The calibration of the *Imin* value needs to be done only once for each EHPR valve. New planters are shipped from the factory with EHPR valves calibrated. Field-installed steering systems are not factory calibrated.

EHPR calibration is required upon any of these events:

- Steering system installation
- EHPR valve cartridge (not coil) replacement
- ECU replacement
- ECU firmware upgrade

Tools Required

- 833-510C HHCT (Hand-Held Calibration Tool)
- 401-312M 3PYP Planter Operator Manual
- 401-312Q 3PYP Planter Pre-Delivery Manual
- The tractor to be used with the planter, having: 300-608 steering console installed, and; tractor steering sensor installed

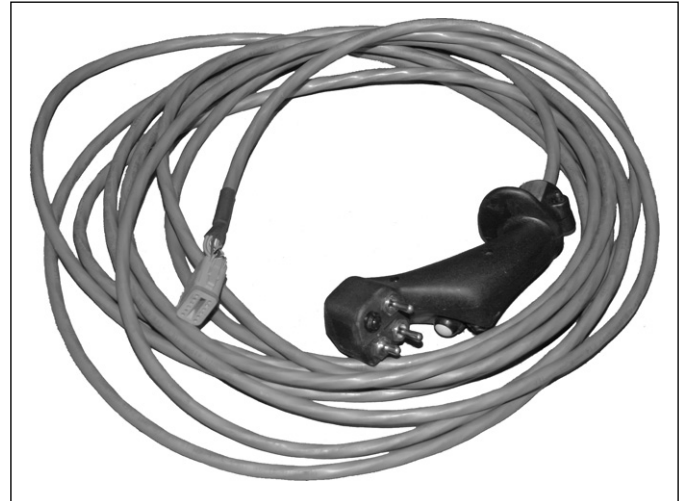

Figure 1
833-510C HHCT

29197

Notations and Conventions

“Left” and “Right” are facing in the direction of machine travel. An orientation rose in the line art illustrations shows the directions of Up, Back, Left, Down, Front, and Right.

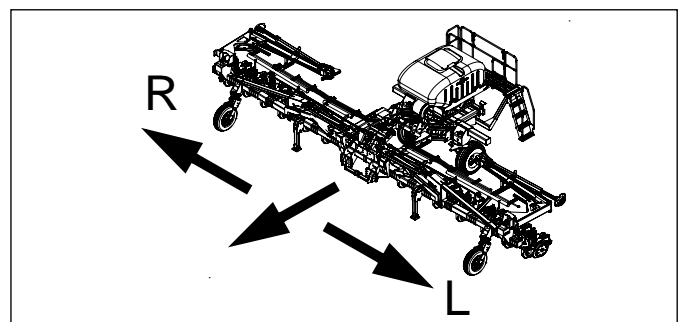
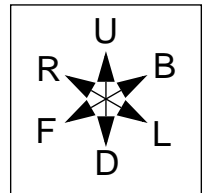

Figure 2
Right / Left

25050

Before You Start

Review these instructions, with the following objectives at each step:

- **Need:**
EHPR calibration is not a routine task. The normal Steering Calibration done at post-delivery does not require the HHCT or these instructions.
- **Pre-requisites:**
ECU must be loaded with valid working firmware. If any update is needed, perform it prior to EHPR calibration.
- **Safety:**
Hydraulic Lines may be under pressure even with tractor circuits in Float.

Frame-mounted coulters have sharp disk blades under the work area.
- **Comprehension:**
Make sure the operator understands where involved components are located, how to use the tools, the steps involved, and what to expect.

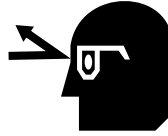

Avoid High Pressure Fluids

Escaping fluid under pressure can penetrate the skin, causing serious injury.

- ▲ *Reduce the hazard by relieving pressure before disconnecting hydraulic lines.*
- ▲ *Wear protective gloves and safety glasses or goggles when working with hydraulic systems.*
- ▲ *Assume lines are pressurized until bled. Slowly open (“crack”) fittings.*
- ▲ *Use a piece of paper or cardboard, NOT BODY PARTS, to check for suspected leaks.*
- ▲ *If an accident occurs, seek immediate medical attention from a physician familiar with this type of injury.*

Pre-Calibration Preparation

Work Location

1. If the planter must be moved prior to calibration, plan the method and route so that only forward moves are necessary. It is not safe to make reverse moves on the planter’s caster wheels when either EHPR or normal Steering Calibration need to be done.

Prepare Planter

2. If a seed hopper or box is mounted, close the slide gate to prevent seed flow.
3. Fully hitch to suitable tractor or hydraulic source. Operate the hydraulic source until the oil is warmed to normal operating temperature.
4. Set tractor steering wheels straight ahead.
5. Hoist, lift or jack up the seed cart so that caster wheels are off ground.
6. Adjust fan/steering system hydraulic circuit to normal operating flow.

Calibrate Sensors

7. Perform the Steering Calibration (see Operator Manual 401-312M) at this time. This calibrates the ECU for the tractor and cart linear displacement sensors. Sensor calibration must be done before EHPR valve calibration.

Note: The cart can be lifted off the ground using its own lift-assist cylinders if the following conditions are met:

The hitched tractor must have sufficient weight.

The shipping stand is installed on the planter.

The lower 1in pins must be installed in the floating lug at each lift-assist cylinder rod end. The shear bolts must be removed. The top link must be left disconnected at the 3-point hitch.

EHPR Valve Calibration

Power-Up Steering System

Refer to Figure 3

1. Set the CALIBRATION switch ③ to center/Off.
2. Set the STEERING OVERRIDE switch ② to down/OFF
3. Set the REVERSE STEER (Power) switch ① to Up/ON
4. Confirm that only the power indicator ④ is illuminated.
5. Engage the hydraulic circuit for Fan/Steering.
6. Briefly toggle the STEERING OVERRIDE switch ② to Up/ON to confirm:
circuit active
flow direction correct (fan rotation direction)

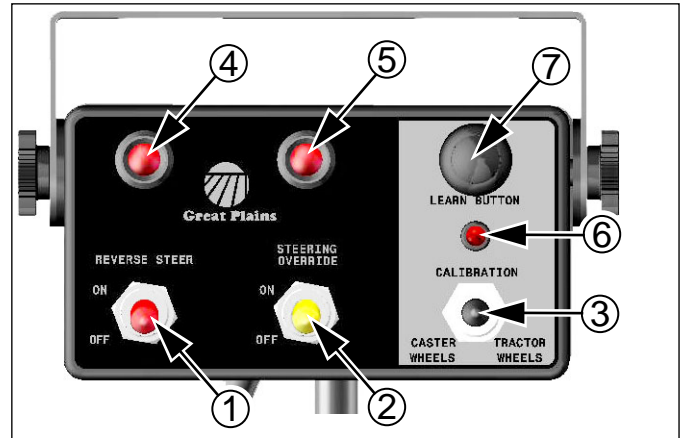

Figure 3
Steering Console

25242

Connect HHCT

Refer to Figure 4

7. Before connecting the HHCT, set the Valve Select switch ① to Center/OFF.

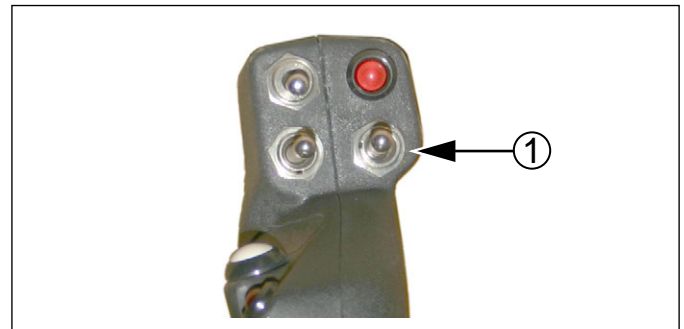

Figure 4
833-510C HHCT Off

29197

Refer to Figure 5

8. At the planter hitch, locate the calibration lead ② from the ECU - it is a short (~18in) cable terminated in a 12-pin plug.
9. Plug the HHCT cable receptacle into the calibration cable plug.

IMPORTANT !

The calibration system is now live. Do not operate any HHCT switches or buttons until instructed.

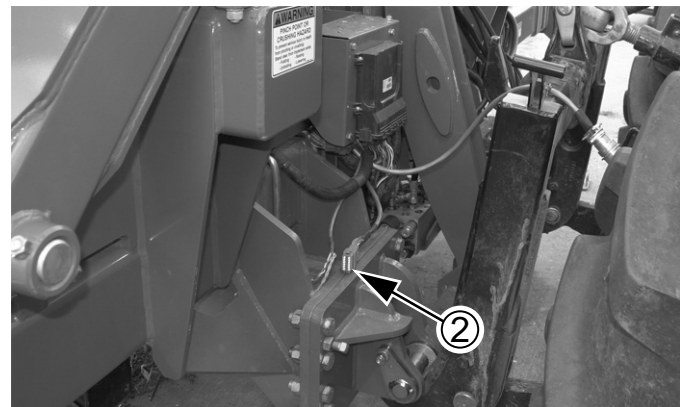

Figure 5
Calibration Harness at ECU

29212

Steer-Right EHPR Valve

Refer to Figure 6

10. Activate steer-right calibration by moving the Valve Select switch ① to the RIGHT.
11. Momentarily move the Imin Adjust toggle switch ② upwards (increase) direction.
12. Wait a few seconds to detect caster rotation. You are looking for very slight [slow] movement.
13. If no movement is detected, repeat step 11 until caster movement is detected. This may require a considerable number of increases.
14. When movement is detected, and just once, momentarily move the Imin Adjust toggle switch ② downward (decrease) direction.
15. Check for caster movement. If caster continues to move repeat step 14 until movement stops.
16. Press and release the Learn Button ③ once. The Learn Acknowledge light ④ should flash.
17. Move the Valve Select switch ① to the center (off) position.

Steer-Left EHPR Valve

18. Activate steer-left calibration by moving the Valve Select switch ① to the LEFT.
19. Momentarily move the Imin Adjust toggle switch ② upwards (increase) direction.
20. Wait a few seconds to detect caster rotation. You are looking for very slight (slow) movement.
21. If no movement is detected, repeat step 19 until caster movement is detected. This may require a considerable number of increases.
22. When movement is detected, and just once, momentarily move the Imin Adjust toggle switch ② downward (decrease) direction.
23. Check for caster movement. If caster continues to move repeat step 22 until movement stops.
24. Press and release the Learn Button ③ once. The Learn Acknowledge light ④ should flash.
25. Move the Valve Select switch ① to the center (off) position.

- ① **Valve Select:**
Left: Steer-Left Valve
Center: Off
Right: Steer-Right Valve
- ② **Imin Adjust:**
Up: Increase Current to Valve
Center: Off
Down: Decrease Current to Valve
- ③ **Learn Button:**
Press and release to store Imin
- ④ **Learn Acknowledge:**
Light flashes when Imin value stored
- ⑤ **Rear Wheel Sensor:**
Up: Enabled
Down: Disabled
- ⑥ **Rear Wheel Sensor Light:**
If switch ⑤ is On, light ⑥ flashes when sensor disk rotates

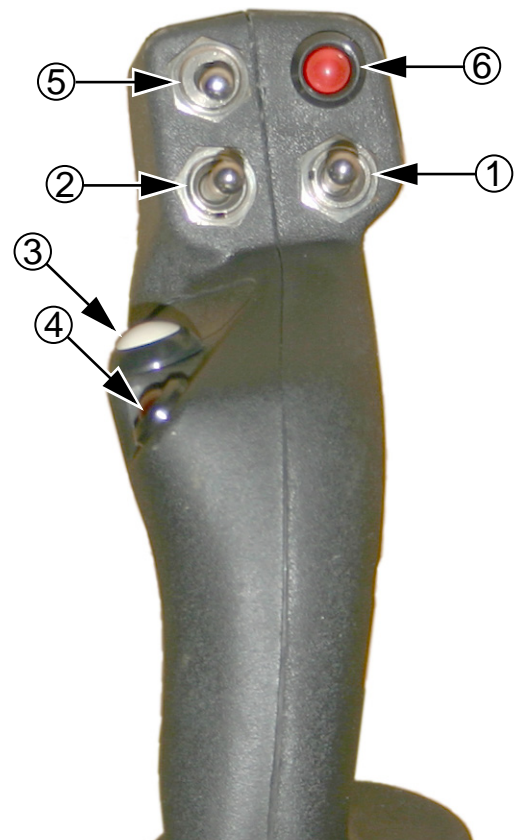

Figure 6
833-510C HHCT Controls

29197

Confirm System Operation

Leave the fan/steering circuit active for these steps.

26. Disconnect the HHCT from the ECU.



CAUTION

Injury Risk:

Be directly ahead or behind, and outside a caster wheel for step 27 through step 29. At one or more steps the caster wheels are likely to pivot under hydraulic power to match the current tractor steering direction. This movement is sudden and forceful, and could knock you down or crush you if you get between the wheel and nearby planter components.

27. Spin the left caster wheel forward. The fan should engage, and manual pivoting of the casters should be possible.
28. Stop the wheel. This may stop the fan. It may or may not be possible to manually pivot the caster.
29. Spin the left caster wheel backwards. The fan should stop/not engage. The casters may pivot to match tractor steering - this could be a small or a large movement. It should not be possible to manually pivot the casters, as it they are now under active hydraulic control.

Closeout

30. Set the fan/steering hydraulic circuit control to Float.
31. At the steering console, set the REVERSE STEER switch OFF (down).
32. Lower the seed cart to the ground.
33. Perform Parking checklist from Operator Manual.

Steering System Operation

See Operator Manual 401-312M.

Great Plains Manufacturing, Inc.

Corporate Office P.O. Box 5060
Salina, Kansas 67402-5060 USA